

BRIGHT-TOOLS

BRIGHT-TOOLS

TOOL HOLDERS

HSK-A

BRIGHT-TOOLS

BRIGHT-TOOLS

BRIGHT-TOOLS

BRIGHT-TOOLS

BRIGHT-TOOLS

BRIGHT-TOOLS

HSK-A Taper Standard HSK-A 锥柄标准

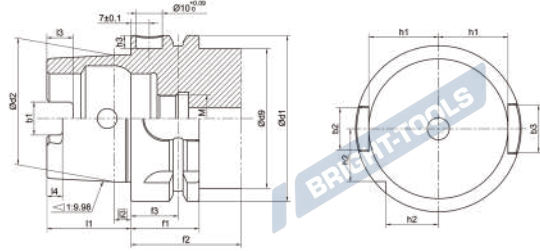
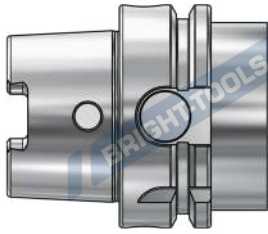

Size	d1	d2	d9	l1	l2	l3	l4	f1	f2	f3	h1	h2	h3	b1	b2	b3
HSK25A	25	19.006	20	13	2.5	4	2	10	20	4.5	10	7.5	-	6.05	6	7
HSK32A	32	24.007	26	16	3.2	5	3	20	35	16	13	9.5	5.4	7.05	7	9
HSK40A	40	30.007	34	20	4	6	3.5	20	35	16	17	12	5.2	8.05	9	11
HSK50A	50	38.009	42	25	5	7.5	4.5	26	42	18	21	15.5	5.1	10.54	12	14
HSK63A	63	48.010	53	32	6.3	10	6	26	42	18	26.5	20	5.0	12.54	16	18
HSK80A	80	60.012	68	40	8	12	8	26	42	18	34	25	4.9	16.04	18	20
HSK100A	100	75.013	88	50	10	15	10	29	45	20	44	31.5	4.9	20.02	20	22

Taper standard: DIN 69893; ISO 12164
Material: Alloyed case hardened steel
Surface Treatment: Blackening and Bright
Taper tolerance: <AT3
Hardness: HRC 56-60
Carbon depth: 0.8±0.2mm
Surface Roughness: Ra<0.2µm
Balancing: G6.3/15000; G2.5/25000

HSK-A TOOLING SYSTEM HSK-A 工具系统目录

ER Collet Chuck.....	G.04
ER 弹簧夹头刀柄	
Power Milling Chuck.....	G.09
强力铣刀柄	
OZ Collet Chuck.....	G.11
OZ 夹头刀柄	
SKS Collet Chuck.....	G.11
SKS 高速筒夹刀柄	
TG Collet Chuck	G.12
TG 超强力刀柄	
Precision Screw Collet Chuck.....	G.13
DC后拉刀柄	
Pull Back Collet Chuck	G.14
NDC后拉刀柄	
Face Mill Holder.....	G.15
面铣刀柄	
Combi Shell Mill Holder	G.19
混合插入式铣刀柄	
End Mill Holder	G.20
侧固刀柄	
Morse Taper Adapter	G.25
带扁尾莫氏刀柄	
Morse Taper Adapter	G.26
带螺纹孔莫氏刀柄	
Tool Holder Adapter Sleeve.....	G.27
转换刀柄	
APU Drill Chuck Holder	G.28
APU 钻夹头刀柄	
Precision Drill Chuck Holder.....	G.28
精密钻夹头刀柄	
Quick Change Tapping Chuck.....	G.29
弹性快换攻丝刀柄	
Screw-in Milling Cutter Holder	G.30
SOM 锁牙刀柄	
Runout Adjustable Flange Adapter	G.32
可调节精度法兰刀柄	
UM Adjustable.....	G.33
UM调零刀柄	
Boring Bar Blank.....	G.34
基础柄	
Test Arbor.....	G.35
主轴检测棒	
Alignment Tool for ATC Arm	G.36
调整机械用手用组合模具	



HSK

ER Collet Chuck with UM Nut

ER 弹簧夹头刀柄

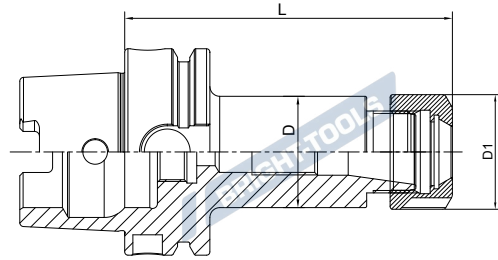
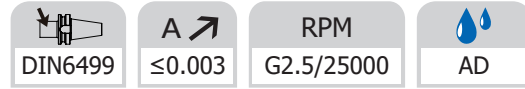

Size	D	D1	L1	Capacity
HSK32A-ER16UM-80	28	32	80	1-10
HSK32A-ER20UM-80	34	35	80	1-13
HSK32A-ER25-80	42	42	80	2-16
HSK32A-ER32-50	50	50	50	3-20
HSK40A-ER16UM-80	28	32	80	1-10
HSK40A-ER20UM-80	34	35	80	1-13
HSK40A-ER25-80	42	42	80	2-16
HSK40A-ER32-80	50	50	80	3-20
HSK50A-ER16UM-80	28	32	80	1-10
HSK50A-ER20UM-80	34	35	80	1-13
HSK50A-ER25-80	42	42	80	2-16
HSK50A-ER32-100	50	50	100	3-20
HSK63A-ER16UM-75	28	32	75	1-10
HSK63A-ER20UM-75	34	35	75	1-13
HSK63A-ER25-75	42	42	75	2-16
HSK63A-ER32-75	50	50	75	3-20
HSK63A-ER40-80	50	63	80	4-26
HSK63A-ER16UM-100	28	32	100	1-10
HSK63A-ER20UM-100	34	35	100	1-13
HSK63A-ER25-100	42	42	100	2-16
HSK63A-ER32-100	50	50	100	3-20
HSK63A-ER40-100	50	63	100	4-26
HSK63A-ER16UM-120	28	32	120	1-10
HSK63A-ER20UM-120	34	35	120	1-13
HSK63A-ER25-120	42	42	120	2-16
HSK63A-ER32-120	50	50	120	3-20
HSK63A-ER40-120	50	63	120	4-26

HSK

ER Collet Chuck with UM Nut
ER 弹簧夹头刀柄

DIN6499	A ≤ 0.003	RPM G2.5/25000	AD
---------	----------------	-------------------	----

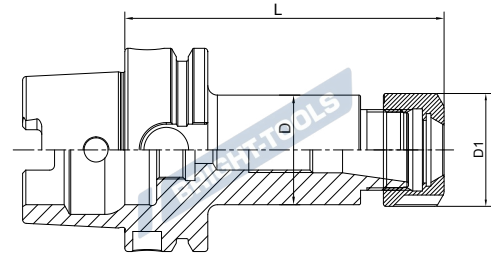

Size	D	D1	L1	Capacity
HSK63A-ER16UM-160T	28	32	160	1-10
HSK63A-ER20UM-160	34	35	160	1-13
HSK63A-ER25-160	42	42	160	2-16
HSK63A-ER32-160	50	50	160	3-20
HSK63A-ER40-160	50	63	160	4-26
HSK63A-ER16UM-200T	28	32	200	1-10
HSK63A-ER20UM-200	34	35	200	1-13
HSK63A-ER25-200	42	42	200	2-16
HSK63A-ER32-200	50	50	200	3-20
HSK63A-ER40-200	50	63	200	4-26
HSK80A-ER16UM-100	28	32	100	1-10
HSK80A-ER20UM-100	34	35	100	1-13
HSK80A-ER25-100	42	42	100	2-16
HSK80A-ER32-100	50	50	100	3-20
HSK80A-ER40-120	50	63	120	4-26
HSK100A-ER16UM-100	28	32	100	1-10
HSK100A-ER20UM-100	34	35	100	1-13
HSK100A-ER25-100	42	42	100	2-16
HSK100A-ER32-100	50	50	100	3-20
HSK100A-ER40-100	63	63	100	4-26
HSK100A-ER50-120	100	78	120	6-34
HSK100A-ER16UM-120	28	32	120	1-10
HSK100A-ER20UM-120	34	35	120	1-13
HSK100A-ER25-120	42	42	120	2-16
HSK100A-ER32-120	50	50	120	3-20
HSK100A-ER40-120	63	63	120	4-26

T refers to cutter side with taper design
T 代表刀具端锥柄设计

HSK

ER Collet Chuck with UM Nut

ER 弹簧夹头刀柄

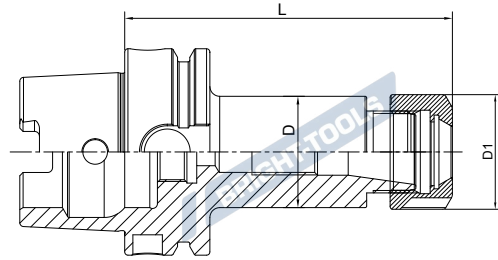
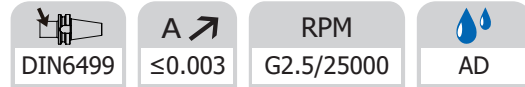

Size	D	D1	L1	Capacity
HSK100A-ER16UM-160T	28	32	160	1-10
HSK100A-ER20UM-160	34	35	160	1-13
HSK100A-ER25-160	42	42	160	2-16
HSK100A-ER32-160	50	50	160	3-20
HSK100A-ER40-160	63	63	160	4-26
HSK100A-ER16UM-200T	28	32	200	1-10
HSK100A-ER20UM-200	34	35	200	1-13
HSK100A-ER25-200	42	42	200	2-16
HSK100A-ER32-200	50	50	200	3-20
HSK100A-ER40-200	63	63	200	4-26
HSK100A-ER25-250	42	42	250	2-16
HSK100A-ER32-250	50	50	250	3-20
HSK100A-ER40-250	63	63	250	4-26
HSK100A-ER25-300	42	42	300	2-16
HSK100A-ER32-300	50	50	300	3-20
HSK100A-ER40-300	63	63	300	4-26
HSK125A-ER40-120	63	63	120	4-26

T refers to cutter side with taper design
T 代表刀具端锥柄设计

ER Collet Chuck with Hex Nut
ER 弹簧夹头刀柄

DIN6499	A ≤ 0.003	RPM G2.5/25000	AD
---------	----------------	-------------------	----

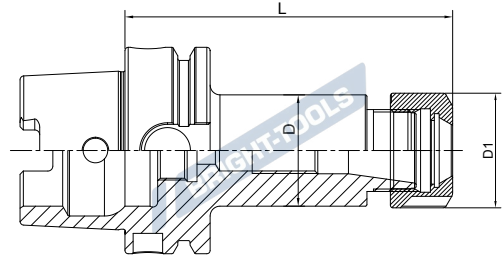

Size	D	D1	L1	Capacity
HSK32A-ER16-80	28	28	80	1-10
HSK32A-ER20-80	34	34	80	1-13
HSK40A-ER16-80	28	28	80	1-10
HSK40A-ER20-80	34	34	80	1-13
HSK50A-ER16-80	28	28	80	1-10
HSK50A-ER20-80	34	34	80	1-13
HSK63A-ER16-75	28	28	75	1-10
HSK63A-ER20-75	34	34	75	1-13
HSK63A-ER16-100	28	28	100	1-10
HSK63A-ER20-100	34	34	100	1-13
HSK63A-ER16-120	28	28	120	1-10
HSK63A-ER20-120	34	34	120	1-13
HSK63A-ER16-160T	28	28	160	1-10
HSK63A-ER20-160	34	34	160	1-13
HSK63A-ER16-200T	28	28	200	1-10
HSK63A-ER20-200	34	34	200	1-13
HSK80A-ER16-100	28	28	100	1-10
HSK80A-ER20-100	34	34	100	1-13
HSK100A-ER16-100	28	28	100	1-10
HSK100A-ER20-100	34	34	100	1-13
HSK100A-ER16-120	28	28	120	1-10
HSK100A-ER20-120	34	34	120	1-13
HSK100A-ER16-160T	28	28	160	1-10
HSK100A-ER20-160	34	34	160	1-13
HSK100A-ER16-200T	28	28	200	1-10
HSK100A-ER20-200	34	34	200	1-13

T refers to cutter side with taper design
 T 代表刀具端锥柄设计

HSK

ER Collet Chuck with Mini Nut

ER 弹簧夹头刀柄

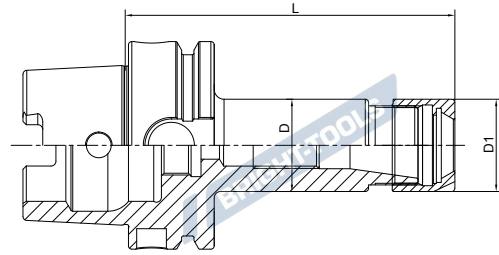
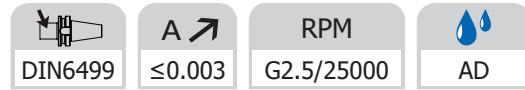

Size	D	D1	L1	Capacity
HSK32A-ER11M-50	16	16	50	1-7
HSK32A-ER16M-50	22	22	50	1-10
HSK32A-ER20M-50	28	28	50	1-13
HSK40A-ER11M-60	16	16	60	1-7
HSK40A-ER16M-60	22	22	60	1-10
HSK40A-ER20M-60	28	28	60	1-13
HSK50A-ER11M-60	16	16	60	1-7
HSK50A-ER16M-60	22	22	60	1-10
HSK50A-ER20M-60	28	28	60	1-13
HSK63A-ER11M-100	16	16	100	1-7
HSK63A-ER16M-100	22	22	100	1-10
HSK63A-ER20M-100	28	28	100	1-13
HSK63A-ER25M-100	35	35	100	2-16
HSK63A-ER11M-160T	16	16	160	1-7
HSK63A-ER16M-160T	22	22	160	1-10
HSK63A-ER20M-160	28	28	160	1-13
HSK63A-ER25M-160	35	35	160	2-16
HSK100A-ER16M-100	22	22	100	1-10
HSK100A-ER20M-100	28	28	100	1-13
HSK100A-ER25M-100	35	35	100	2-16
HSK100A-ER16M-160T	22	22	160	1-10
HSK100A-ER20M-160	28	28	160	1-13
HSK100A-ER25M-160	35	35	160	2-16

T refers to cutter side with taper design
T 代表刀具端锥柄设计

ER Collet Chuck with GER Nut
GER 弹簧夹头刀柄

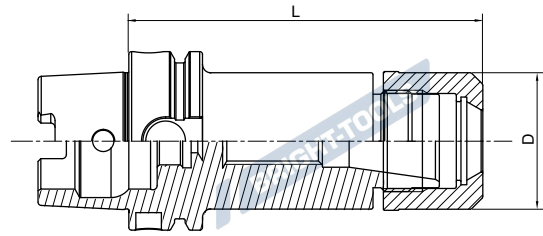
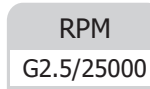
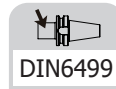

Size	D	L	Capacity
HSK63A-GER16-100	30	100	1-10
HSK63A-GER16-160	30	160	1-10
HSK63A-GER20-100	35	100	1-13
HSK63A-GER20-160	35	160	1-13
HSK63A-GER25-100	40	100	2-16
HSK63A-GER25-160	40	160	2-16
HSK63A-GER32-100	48	100	2-20
HSK63A-GER32-160	48	160	2-20
HSK100A-GER16-100	30	100	1-10
HSK100A-GER16-160	30	160	1-10
HSK100A-GER20-100	35	100	1-13
HSK100A-GER20-160	35	160	1-13
HSK100A-GER25-100	40	100	2-16
HSK100A-GER25-160	40	160	2-16
HSK100A-GER32-100	48	100	2-20
HSK100A-GER32-160	48	160	2-20

HSK



Power Milling Chuck

强力铣刀柄

 A ↗
 ≤0.008

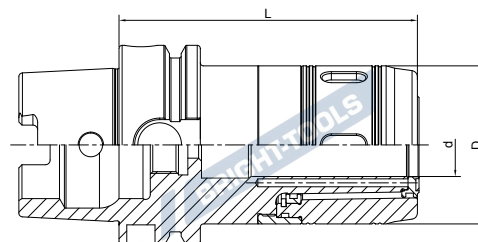
 AD

Size	d	D	L	Capacity
HSK63A-HC20-100	20	50	100	3-16; 20
HSK63A-HC25-100	25	59	100	3-20; 25
HSK63A-HC32-120	32	72	120	3-25; 32
HSK100A-HC20-105	20	50	105	3-16; 20
HSK100A-HC25-105	25	59	105	3-20; 25
HSK100A-HC32-120	32	72	120	3-25; 32
HSK100A-HC32-165	32	72	165	3-25; 32
HSK100A-HC32-200	32	72	200	3-25; 32

HSK

Power Milling Chuck
强力铣刀柄

NEW

A ↗
≤0.005

AD



Type 1

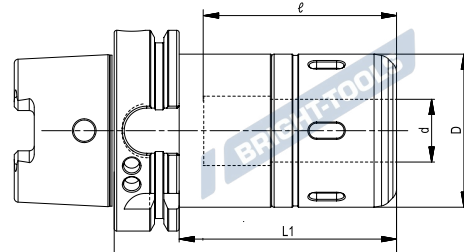

Type 2

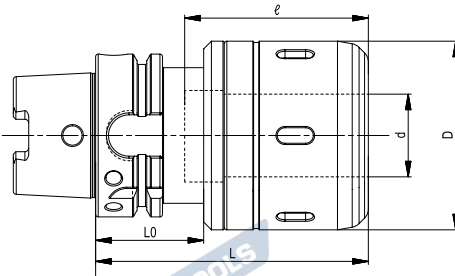

Type 3

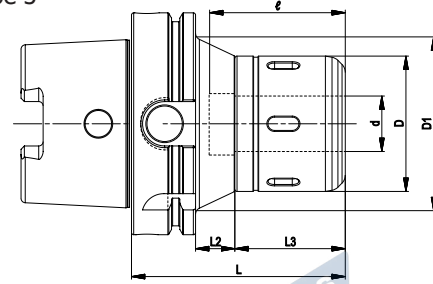

Size	Type	d	D	D1	L	L1	L2	L3	l	L0	G
HSK63A-CT16SA-90	1	16	45	-	90	64	-	-	60	-	M8
HSK63A-CT20SA-90	1	20	52	-	90	64	-	-	60	-	M8
HSK63A-CT25SA-105	2	25	61	-	105	-	-	-	75	42	M8
HSK63A-CT32SA-105	2	32	73	-	105	-	-	-	75	42	M8
HSK63A-CT32SA-120	2	32	73	-	120	-	-	-	90	42	M8
HSK100A-CT16SA-90	3	16	45	56	90	-	16	45	55	-	M10
HSK100A-CT20SA-105	3	20	52	64	105	-	18	58	70	-	M10
HSK100A-CT25SA-105	3	25	61	74	105	-	20	56	70	-	M10
HSK100A-CT25SA-135	3	25	61	74	135	-	50	56	80	-	M10
HSK100A-CT32SA-105	1	32	73	-	105	76	-	-	70	-	M10
HSK100A-CT32SA-120	1	32	73	-	120	91	-	-	85	-	M10
HSK100A-CT32SA-135	1	32	73	-	135	106	-	-	100	-	M10
HSK100A-CT42SA-105	2	42	88	-	105	-	-	-	70	45	M10
HSK100A-CT42SA-135	2	42	88	-	135	-	-	-	100	45	M10
HSK100A-CT42SA-165	2	42	88	-	165	-	-	-	120	45	M10

HSK

BRIGHT-TOOLS

BRIGHT-TOOLS

High Speed SKS Collet Chuck

SKS 高速筒夹刀柄

A ↗ ≤0.003	RPM G2.5/25000	 AD
---------------	-------------------	---

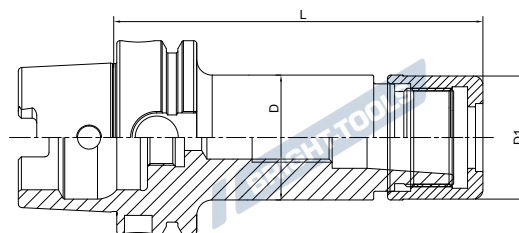

Size	D	D1	L	Capacity	M
HSK63A-SKS10-90	27.5	27	90	2-10	M21.5*1
HSK63A-SKS16-90	40.6	40	90	3-16	M32*1.5
HSK63A-SKS10-120	27.5	27	120	2-10	M21.5*1
HSK63A-SKS16-120	40.6	40	120	3-16	M32*1.5
HSK100A-SKS10-90	27.5	27	90	2-10	M21.5*1
HSK100A-SKS16-90	40.6	40	90	3-16	M32*1.5
HSK100A-SKS10-120	27.5	27	120	2-10	M21.5*1
HSK100A-SKS16-120	40.6	40	120	3-16	M32*1.5

HSK

OZ Collet Chuck
OZ 夹头刀柄

DIN6391	A ≤ 0.005	RPM G2.5/25000	AD
---------	----------------	----------------	----

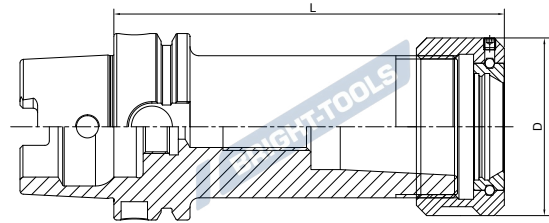

Size	D	L	Capacity
HSK50A-OZ16-90	43	90	2-16
HSK50A-OZ25-110	60	110	2-25
HSK63A-OZ16-100	43	100	2-16
HSK63A-OZ25-100	60	100	2-25
HSK63A-OZ32-120	72	120	3-32
HSK100A-OZ16-110	43	110	2-16
HSK100A-OZ25-120	60	120	2-25
HSK100A-OZ32-130	72	130	3-32

HSK

TG Collet Chuck
TG 超强力刀柄

A ≤ 0.005	AD
----------------	----

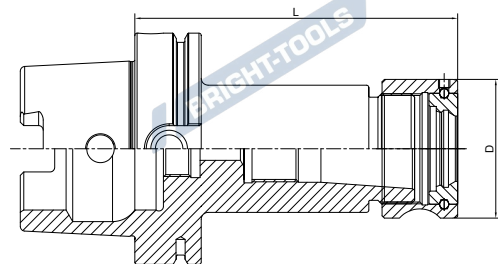

Size	D	L	Collet	Capacity
HSK50A-TG75-110	50	110	TG 75	2-20
HSK63A-TG75-120	50	120	TG 75	2-20
HSK63A-TG100-130	60	130	TG 100	3-25
HSK100A-TG75-120	50	120	TG 100	3-20
HSK100A-TG100-130	60	130	TG 100	3-25

Pull Back Collet Chuck DC 后拉刀柄

A ↗ ≤0.003	RPM G2.5/25000	 AD
---------------	-------------------	---

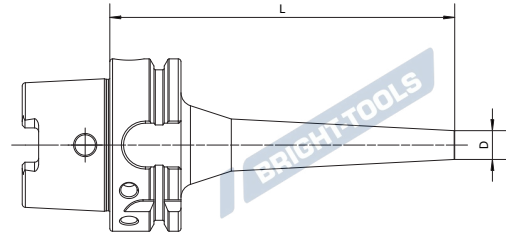

Size	D	L	Capacity
HSK63A-DC06-60	14	60	1-6
HSK63A-DC06-90	14	90	1-6
HSK63A-DC06-120	14	120	1-6
HSK63A-DC06-150	14	150	1-6
HSK63A-DC08-60	22	60	1-10
HSK63A-DC08-90	22	90	1-10
HSK63A-DC08-120	22	120	1-10
HSK63A-DC08-150	22	150	1-10
HSK63A-DC08-200	22	200	1-10
HSK63A-DC12-90	34	90	1-12
HSK63A-DC12-120	34	120	1-12
HSK63A-DC12-150	34	150	1-12
HSK63A-DC12-200	34	200	1-12
HSK100A-DC06-110	14	110	1-6
HSK100A-DC06-150	14	150	1-6
HSK100A-DC08-110	22	110	1-10
HSK100A-DC08-150	22	150	1-10
HSK100A-DC08-200	22	200	1-10
HSK100A-DC12-120	34	120	1-12
HSK100A-DC12-150	34	150	1-12
HSK100A-DC12-200	34	200	1-12

Precision Screw Collet Chuck
NDC 后拉刀柄

A ↗ ≤0.003	RPM G2.5/25000	AD
---------------	-------------------	----

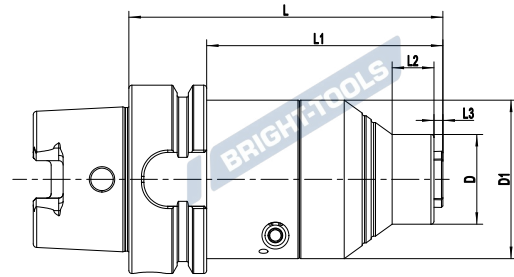

Size	D	D1	L	L1	L2	L3
HSK63A-NDC14-105	30	53	105	79	14	3
HSK63A-NDC14-150	30	53	150	124	59	3
HSK63A-NDC20-105	40	53	105	79	16	3
HSK100A-NDC32-145	70	-	145	116	15	3.5

HSK



Face Mill Holder Inch 英制面铣刀柄

A ↗ ≤0.005	RPM G2.5/25000	AD
---------------	-------------------	----

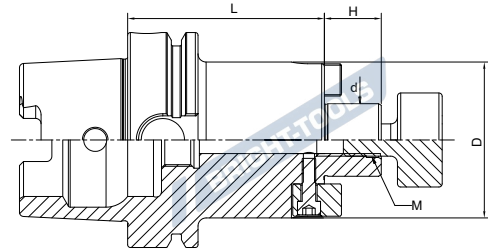

Size	d	D	H	L	M
HSK63A-FMA3/4"-50	3/4"	42.926	17.45	50	3/8-24
HSK63A-FMA1"-60	1"	55.626	17.45	60	1/2-20
HSK63A-FMA1-1/4"-60	1-1/4"	69.85	17.45	60	5/8-18
HSK63A-FMA1-1/2"-60	1-1/2"	78	23.83	60	3/4-16
HSK63A-FMA3/4"-100	3/4"	42.926	17.45	100	3/8-24
HSK63A-FMA1"-100	1"	55.626	17.45	100	1/2-20
HSK63A-FMA1-1/4"-100	1-1/4"	69.85	17.45	100	5/8-18
HSK63A-FMA1-1/2"-100	1-1/2"	78	23.83	100	3/4-16
HSK63A-FMA3/4"-160	3/4"	42.926	17.45	160	3/8-24
HSK63A-FMA1"-160	1"	55.626	17.45	160	1/2-20
HSK63A-FMA1-1/4"-160	1-1/4"	69.85	17.45	160	5/8-18
HSK63A-FMA1-1/2"-160	1-1/2"	78	23.83	160	3/4-16
HSK100A-FMA3/4"-50	3/4"	42.926	17.45	50	3/8-24
HSK100A-FMA1"-50	1"	55.626	17.45	50	1/2-20
HSK100A-FMA1-1/4"-60	1-1/4"	69.85	17.45	60	5/8-18
HSK100A-FMA1-1/2"-60	1-1/2"	78	23.83	60	3/4-16
HSK100A-FMA3/4"-100	3/4"	42.926	17.45	100	3/8-24
HSK100A-FMA1"-100	1"	55.626	17.45	100	1/2-20
HSK100A-FMA1-1/4"-100	1-1/4"	69.85	17.45	100	5/8-18
HSK100A-FMA1-1/2"-100	1-1/2"	78	23.83	100	3/4-16
HSK100A-FMA3/4"-160	3/4"	42.926	17.45	160	3/8-24
HSK100A-FMA1"-160	1"	55.626	17.45	160	1/2-20
HSK100A-FMA1-1/4"-160	1-1/4"	69.85	17.45	160	5/8-18
HSK100A-FMA1-1/2"-160	1-1/2"	78	23.83	160	3/4-16
HSK125A-FMA3/4"-2-60	3/4"	42.926	17.45	60	3/8-24
HSK125A-FMA1"-60	1"	55.626	17.45	60	1/2-20
HSK125A-FMA1-1/2"-60	1-1/2"	78	23.83	60	3/4-16
HSK125A-FMA1"-100	1"	55.626	17.45	100	1/2-20
HSK125A-FMA1-1/4"-100	1-1/4"	69.85	17.45	100	5/8-18
HSK125A-FMA1-1/2"-100	1-1/2"	78	23.83	100	3/4-16
HSK125A-FMA2"-100	2"	124	-	100	-

Face Mill Holder
面铣刀柄

DIN6357	A ↗ ≤0.005	RPM G2.5/25000	AD
----------------	----------------------	--------------------------	-----------

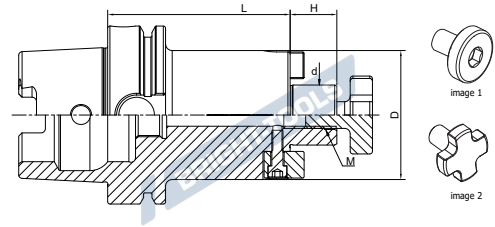

Size	d	D	H	L	M
HSK50A-FMB16-50	16	38	17	50	M8
HSK50A-FMB22-60	22	48	19	60	M10
HSK50A-FMB27-60	27	58	21	60	M12
HSK50A-FMB32-60	32	78	24	60	M16
HSK63A-FMB16-50	16	38	17	50	M8
HSK63A-FMB22-50	22	48	19	50	M10
HSK63A-FMB27-60	27	58	21	60	M12
HSK63A-FMB32-60	32	78	24	60	M16
HSK63A-FMB16-100	16	38	17	100	M8
HSK63A-FMB22-100	22	48	19	100	M10
HSK63A-FMB27-100	27	58	21	100	M12
HSK63A-FMB32-100	32	78	24	100	M16
HSK63A-FMB16-160	16	38	17	160	M8
HSK63A-FMB22-160	22	48	19	160	M10
HSK63A-FMB27-160	27	58	21	160	M12
HSK63A-FMB32-160	32	78	24	160	M16
HSK63A-FMB16-200	16	38	17	200	M8
HSK63A-FMB22-200	22	48	19	200	M10
HSK63A-FMB27-200	27	58	21	200	M12
HSK63A-FMB32-200	32	78	24	200	M16
HSK80A-FMB22-50	22	48	19	50	M10
HSK80A-FMB27-50	27	58	21	50	M12
HSK80A-FMB32-60	32	78	24	60	M16

Face mill holder is with retaining screw (image 2) except China, it is with universal screw (image 1) in China.
中国市场面铣刀柄标配圆头螺钉 (图 1), 其他国家标配十字花螺钉 (图 2).

AD/B Customized
AD/B 可定制

Face Mill Holder 面铣刀柄



DIN6357	A \nearrow ≤ 0.003	RPM G2.5/25000	AD
---------	------------------------------	-------------------	----

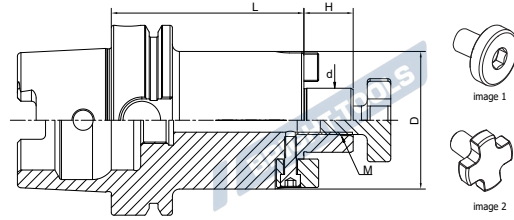

Size	d	D	H	L	M
HSK100A-FMB16-50	16	38	17	50	M8
HSK100A-FMB22-50	22	48	19	50	M10
HSK100A-FMB27-50	27	58	21	50	M12
HSK100A-FMB32-60	32	78	24	60	M16
HSK100A-FMB16-100	16	38	17	100	M8
HSK100A-FMB22-100	22	48	19	100	M10
HSK100A-FMB27-100	27	58	21	100	M12
HSK100A-FMB32-100	32	78	24	100	M16
HSK100A-FMB16-160	16	38	17	160	M8
HSK100A-FMB22-160	22	48	19	160	M10
HSK100A-FMB27-160	27	58	21	160	M12
HSK100A-FMB32-160	32	78	24	160	M16
HSK100A-FMB16-200	16	38	17	200	M8
HSK100A-FMB22-200	22	48	19	200	M10
HSK100A-FMB27-200	27	58	21	200	M12
HSK100A-FMB32-200	32	78	24	200	M16
HSK100A-FMB16-250	16	38	17	250	M8
HSK100A-FMB22-250	22	48	19	250	M10
HSK100A-FMB27-250	27	58	21	250	M12
HSK100A-FMB32-250	32	78	24	250	M16
HSK100A-FMB22-300	22	48	19	300	M10
HSK100A-FMB27-300	27	58	21	300	M12
HSK100A-FMB32-300	32	78	24	300	M16
HSK125A-FMB22-60	22	48	19	60	M10
HSK125A-FMB27-60	27	58	21	60	M12
HSK125A-FMB32-60	32	78	24	60	M16
HSK125A-FMB27-100	27	58	21	100	M12
HSK125A-FMB32-100	32	78	24	100	M16

Face Mill Holder
面铣刀柄

DIN6357	A ≤ 0.005	RPM G2.5/25000	AD
---------	----------------	----------------	----

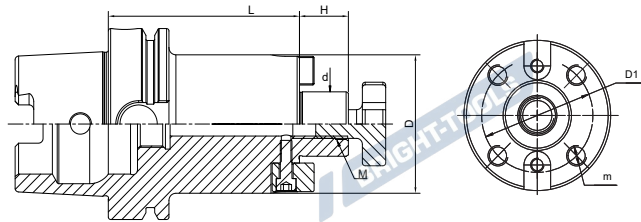

Size	d	D	D1	H	L	M	m
HSK63A-FMB40-60	40	88	66.7	27	60	M20	M12
HSK63A-FMB40-100	40	88	66.7	27	100	M20	M12
HSK63A-FMB40-160	40	88	66.7	27	160	M20	M12
HSK63A-FMB40-200	40	88	66.7	27	200	M20	M12
HSK80A-FMB40-60	40	88	66.7	27	60	M20	M12
HSK100A-FMB40-60	40	88	66.7	27	60	M20	M12
HSK100A-FMB60-70	60	129	101.6	25	70	M30	M16
HSK100A-FMB40-100	40	88	66.7	27	100	M20	M12
HSK100A-FMB40-160	40	88	66.7	27	160	M20	M12
HSK100A-FMB40-200	40	88	66.7	27	200	M20	M12
HSK100A-FMB40-250	40	88	66.7	27	250	M20	M12
HSK100A-FMB40-300	40	88	66.7	27	300	M20	M12
HSK125A-FMB40-60	40	88	66.7	27	60	M20	M12
HSK125A-FMB40-100	40	88	66.7	27	100	M20	M12

FMB40 tool holder is with one retaining screw (image 2) . but it is with one universal screw (image 1) in China.

FMB40 刀柄中国市场面铣刀柄标配圆头螺钉 (图 1)，其他国家标配十字花螺钉 (图 2)。

Combi Shell Mill Holder

混合插入式铣刀柄

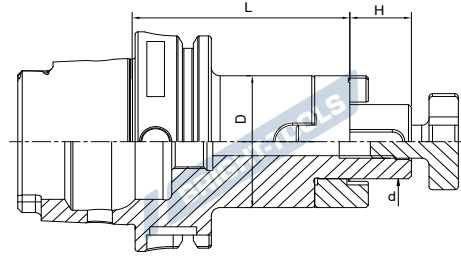

Size	d	D	L	L1
HSK50A-SEMC16-50	16	32	50	17
HSK50A-SEMC22-50	22	40	50	19
HSK50A-SEMC27-65	27	48	65	21
HSK50A-SEMC32-65	32	58	65	24
HSK63A-SEMC16-60	16	32	60	17
HSK63A-SEMC22-60	22	40	60	19
HSK63A-SEMC27-60	27	48	60	21
HSK63A-SEMC32-60	32	58	60	24
HSK63A-SEMC40-70	40	70	70	27
HSK63A-SEMC16-100	16	32	100	17
HSK63A-SEMC22-100	22	40	100	19
HSK63A-SEMC27-100	27	48	100	21
HSK63A-SEMC32-100	32	58	100	24
HSK80A-SEMC16-60	16	32	60	17
HSK80A-SEMC22-60	22	40	60	19
HSK80A-SEMC27-60	27	48	60	21
HSK80A-SEMC32-60	32	58	60	24
HSK80A-SEMC40-70	40	70	70	27
HSK100A-SEMC16-60	16	32	60	17
HSK100A-SEMC22-60	22	40	60	19
HSK100A-SEMC27-60	27	48	60	21
HSK100A-SEMC32-60	32	58	60	24
HSK100A-SEMC40-70	40	70	70	27

End Mill Holder Weldon
侧固刀柄

DIN6359/1835B	A \nearrow ≤ 0.005	RPM G2.5/25000	AD
---------------	---------------------------	----------------	----

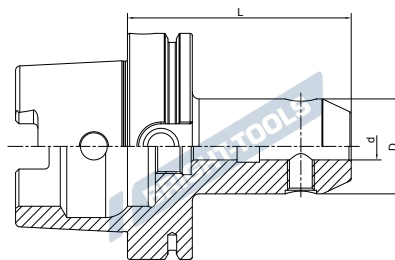

Size	d	D	L	M	Screw Quantity
HSK50A-SLA06-65	6	25	65	M6	1
HSK50A-SLA08-65	8	28	65	M8	1
HSK50A-SLA10-65	10	35	65	M10	1
HSK50A-SLA12-80	12	42	80	M12	1
HSK50A-SLA14-80	14	44	80	M12	1
HSK50A-SLA16-80	16	48	80	M14	1
HSK50A-SLA18-80	18	50	80	M14	1
HSK50A-SLA20-80	20	52	80	M16	1
HSK50A-SLA25-110	25	60	110	M18*2	2
HSK50A-SLA32-110	32	60	110	M20*2	2
HSK63A-SLA06-65	6	28	65	M6	1
HSK63A-SLA08-65	8	35	65	M8	1
HSK63A-SLA10-65	10	42	65	M10	1
HSK63A-SLA12-80	12	44	80	M12	1
HSK63A-SLA14-80	14	48	80	M12	1
HSK63A-SLA16-80	16	52	80	M14	1
HSK63A-SLA20-80	20	65	80	M16	1
HSK63A-SLA25-110	25	72	110	M18*2	2
HSK63A-SLA32-110	32	80	110	M20*2	2
HSK63A-SLA40-125	40		125	M20*2	2
		25			
HSK63A-SLA06-100	6	28	100	M6	1
HSK63A-SLA08-100	8	35	100	M8	1
HSK63A-SLA10-100	10	44	100	M10	1
HSK63A-SLA14-100	14	48	100	M12	1
HSK63A-SLA16-100	16	50	100	M12	1
HSK63A-SLA18-100	18	52	100	M14	1
HSK63A-SLA20-100	20	25	100	M16	1

HSK



End Mill Holder Weldon 侧固刀柄

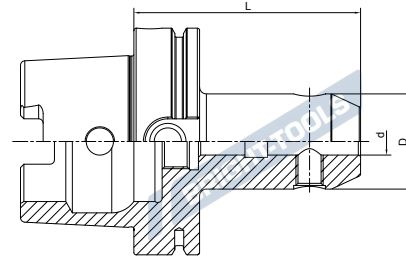

Size	d	D	L	M	Screw Quantity
HSK63A-SLA06-160	6	25	160	M6	1
HSK63A-SLA08-160	8	28	160	M8	1
HSK63A-SLA10-160	10	35	160	M10	1
HSK63A-SLA12-160	12	42	160	M12	1
HSK63A-SLA14-160	14	44	160	M12	1
HSK63A-SLA16-160	16	48	160	M14	1
HSK63A-SLA18-160	18	50	160	M14	1
HSK63A-SLA20-160	20	52	160	M16	1
HSK63A-SLA25-160	25	65	160	M18*2	2
HSK63A-SLA32-160	32	72	160	M20*2	2
HSK80A-SLA06-80	6	25	80	M6	1
HSK80A-SLA08-80	8	28	80	M8	1
HSK80A-SLA10-80	10	35	80	M10	1
HSK80A-SLA12-80	12	42	80	M12	1
HSK80A-SLA14-80	14	44	80	M12	1
HSK80A-SLA16-100	16	48	100	M14	1
HSK80A-SLA18-100	18	50	100	M14	1
HSK80A-SLA20-100	20	52	100	M16	1
HSK80A-SLA25-100	25	65	100	M18*2	2
HSK80A-SLA32-110	32	72	110	M20*2	2
HSK80A-SLA40-120	40	80	120	M20*2	2
HSK100A-SLA08-80	8	28	80	M8	1
HSK100A-SLA10-80	10	35	80	M10	1
HSK100A-SLA12-80	12	42	80	M12	1
HSK100A-SLA14-80	14	44	80	M12	1
HSK100A-SLA16-100	16	48	100	M14	1
HSK100A-SLA18-100	18	50	100	M14	1
HSK100A-SLA20-100	20	52	100	M16	1
HSK100A-SLA25-100	25	65	100	M18*2	2
HSK100A-SLA32-100	32	72	100	M20*2	2
HSK100A-SLA40-105	40	80	105	M20*2	2
HSK100A-SLA50-130	50	100	130	M24*2	2

End Mill Holder Weldon
侧固刀柄

DIN6359/1835B	A ≤0.005	RPM G2.5/25000	AD
---------------	----------	----------------	----

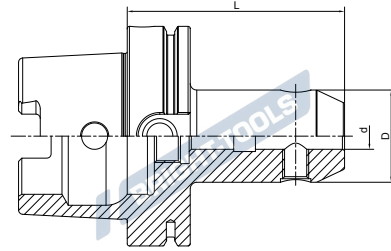





Size	d	D	L	M	Screw Quantity
HSK100A-SLA08-160	8	28	160	M8	1
HSK100A-SLA10-160	10	35	160	M10	1
HSK100A-SLA12-160	12	42	160	M12	1
HSK100A-SLA14-160	14	44	160	M12	1
HSK100A-SLA16-160	16	48	160	M14	1
HSK100A-SLA18-160	18	50	160	M14	1
HSK100A-SLA20-160	20	52	160	M16	1
HSK100A-SLA25-160	25	65	160	M18*2	2
HSK100A-SLA32-160	32	72	160	M20*2	2
HSK100A-SLA40-160	40	80	160	M20*2	2
HSK125A-SLA10-80	10	35	80	M10	1
HSK125A-SLA12-80	12	42	80	M12	1
HSK125A-SLA14-80	14	44	80	M12	1
HSK125A-SLA16-100	16	48	100	M14	1
HSK125A-SLA20-100	20	52	100	M16	1
HSK125A-SLA25-100	25	65	100	M18*2	2
HSK125A-SLA32-100	32	72	100	M20*2	2
HSK125A-SLA40-105	40	80	105	M20*2	2
HSK125A-SLA50-130	50	100	130	M24*2	2

HSK

End Mill Holder with Coolant Channels

侧固刀柄, 端面出水型

 DIN6359/1835B	 A ≤0.005	 RPM G2.5/25000	 AD
--	--	--	---

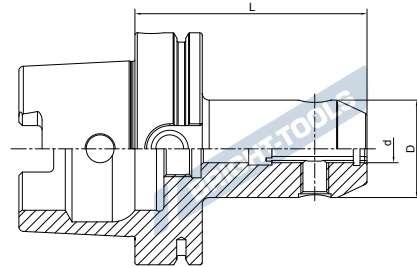

Size	d	D	L	M	Screw Quantity
HSK63A-SLA06-65K	6	25	65	M6	1
HSK63A-SLA08-65K	8	28	65	M8	1
HSK63A-SLA10-65K	10	35	65	M10	1
HSK63A-SLA12-80K	12	42	80	M12	1
HSK63A-SLA14-80K	14	44	80	M12	1
HSK63A-SLA16-80K	16	48	80	M14	1
HSK63A-SLA18-80K	18	50	80	M14	1
HSK63A-SLA20-80K	20	52	80	M16	1
HSK63A-SLA25-110K	25	65	110	M18*2	2
HSK63A-SLA32-110K	32	72	110	M20*2	2
HSK63A-SLA40-125K	40	80	125	M20*2	2
HSK100A-SLA06-80K	6	25	80	M6	1
HSK100A-SLA08-80K	8	28	80	M8	1
HSK100A-SLA10-80K	10	35	80	M10	1
HSK100A-SLA12-80K	12	42	80	M12	1
HSK100A-SLA14-80K	14	44	80	M12	1
HSK100A-SLA16-100K	16	48	100	M14	1
HSK100A-SLA18-100K	18	50	100	M14	1
HSK100A-SLA20-100K	20	52	100	M16	1
HSK100A-SLA25-100K	25	65	100	M18*2	2
HSK100A-SLA32-100K	32	72	100	M20*2	2
HSK100A-SLA40-105K	40	80	105	M20*2	2

HSK

End Mill Holder Whistle Notch

侧固式铣刀柄, 斜 2 度

DIN1835E	A \nearrow ≤ 0.005	RPM G2.5/25000	AD
----------	------------------------------	-------------------	----

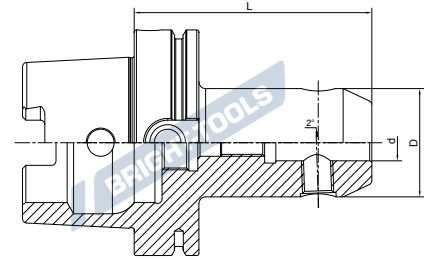

Size	d	D	L	M	Screw Quantity
HSK63A-SLB06-80	6	25	80	M6	1
HSK63A-SLB08-80	8	28	80	M8	1
HSK63A-SLB10-80	10	35	80	M10	1
HSK63A-SLB12-90	12	42	90	M12	1
HSK63A-SLB14-90	14	44	90	M12	1
HSK63A-SLB16-100	16	48	100	M14	1
HSK63A-SLB18-100	18	50	100	M14	1
HSK63A-SLB20-100	20	52	100	M16	1
HSK63A-SLB25-110	25	65	110	M18*2	2
HSK63A-SLB32-110	32	72	110	M20*2	2
HSK63A-SLB40-125	40	80	125	M20*2	2
HSK100A-SLB06-90	6	25	90	M6	1
HSK100A-SLB08-90	8	28	90	M8	1
HSK100A-SLB10-90	10	35	90	M10	1
HSK100A-SLB12-100	12	42	100	M12	1
HSK100A-SLB14-100	14	44	100	M12	1
HSK100A-SLB16-100	16	48	100	M14	1
HSK100A-SLB18-100	18	50	100	M14	1
HSK100A-SLB20-110	20	52	110	M16	1
HSK100A-SLB25-120	25	65	120	M18*2	2
HSK100A-SLB32-120	32	72	120	M20*2	2
HSK100A-SLB40-120	40	80	120	M20*2	2
HSK125A-SLB20-120	20	52	120	M16	1
HSK125A-SLB25-130	25	65	130	M18*2	2
HSK125A-SLB32-130	32	72	130	M20*2	2

HSK



Morse Taper Adapter with Tang

带扁尾莫氏刀柄

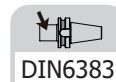
 DIN6383

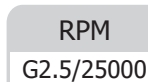
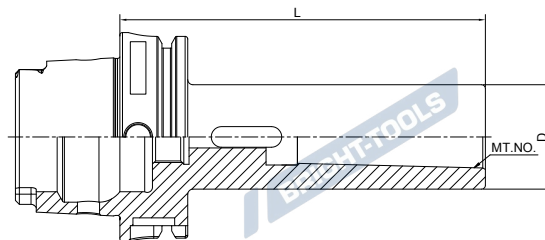

 A ≤ 0.005

 RPM
G2.5/25000

Size	MT. NO.	D	L
HSK50A-MTA1-100	1	25	100
HSK50A-MTA2-120	2	32	120
HSK50A-MTA3-140	3	40	140
HSK63A-MTA1-100	1	25	100
HSK63A-MTA2-120	2	32	120
HSK63A-MTA3-140	3	40	140
HSK63A-MTA4-160	4	48	160
HSK80A-MTA1-110	1	25	110
HSK80A-MTA2-120	2	32	120
HSK80A-MTA3-140	3	40	140
HSK80A-MTA4-160	4	48	160
HSK100A-MTA1-110	1	25	110
HSK100A-MTA2-120	2	32	120
HSK100A-MTA3-150	3	40	150
HSK100A-MTA4-170	4	48	170
HSK100A-MTA5-200	5	63	200

HSK

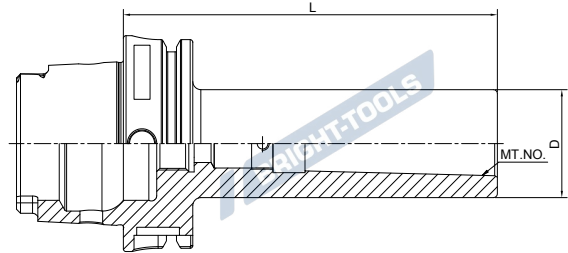
Morse Taper Adapter with Drawbar
带螺纹孔莫氏刀柄

DIN6364	A ≤ 0.005	RPM G2.5/25000
---------	----------------	-------------------



Size	MT. NO.	D	L
HSK50A-MTB1-100	1	25	100
HSK50A-MTB2-120	2	32	120
HSK50A-MTB3-140	3	40	140
HSK63A-MTB1-100	1	25	100
HSK63A-MTB2-120	2	32	120
HSK63A-MTB3-140	3	40	140
HSK63A-MTB4-160	4	48	160
HSK80A-MTB1-110	1	25	110
HSK80A-MTB2-120	2	32	120
HSK80A-MTB3-150	3	40	150
HSK80A-MTB4-170	4	48	170
HSK100A-MTB1-110	1	25	110
HSK100A-MTB2-120	2	32	120
HSK100A-MTB3-150	3	40	150
HSK100A-MTB4-170	4	48	170
HSK100A-MTB5-200	5	63	200

HSK

Tool Holder Adapter Sleeve

转换刀柄

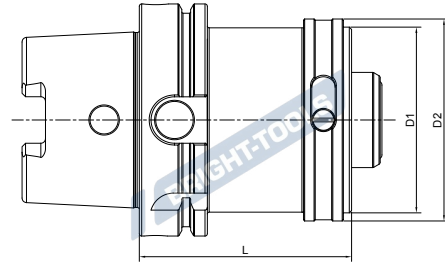

Size	D1	D2	L
HSK50A-HSK50C-80	50	55	80
HSK50A-HSK50C-100	50	55	100
HSK63A-HSK63C-100	63	70	100
HSK63A-HSK63C-140	63	70	140
HSK80A-HSK80C-120	80	87	120
HSK80A-HSK80C-160	80	87	160
HSK100A-HSK100C-140	100	110	140
HSK100A-HSK100C-200	100	110	200
HSK50A-HSK32C-60	32	37	60
HSK50A-HSK32C-70	40	45	70
HSK63A-HSK32C-70	32	37	70
HSK63A-HSK40C-80	40	45	80
HSK63A-HSK50C-80	50	55	80
HSK80A-HSK40C-80	40	45	80
HSK80A-HSK50C-80	50	55	80
HSK80A-HSK63C-100	63	70	100
HSK100A-HSK50C-80	50	55	80
HSK100A-HSK63C-100	63	70	100
HSK100A-HSK80C-100	80	87	100
HSK125A-HSK63C-100	63	70	100

HSK

APU Drill Chuck Holder
APU 钻夹头刀柄

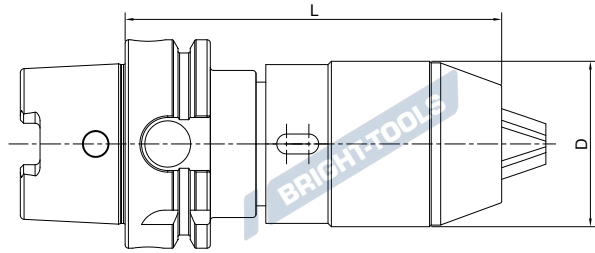

Size	D	L	Capacity
HSK63A-APU13-130	48	130	1-13
HSK63A-APU16-140	53	140	3-16
HSK100A-APU13-140	48	140	1-13
HSK100A-APU16-150	53	150	3-16

HSK

Precision Drill Chuck Holder
精密钻夹头刀柄

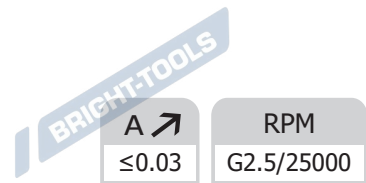

Size	D	D1	L	L1	Capacity
HSK63A-CPU10-90	38	50	90	32	1-10
HSK63A-CPU13-100	50	-	100	-	1-13
HSK63A-CPU16-100	50	-	100	-	1-16
HSK100A-CPU13-105	50	-	105	-	1-13
HSK100A-CPU16-105	50	-	105	-	1-16



Quick Change Tapping Chuck with Length Compensation

弹性快换攻丝刀柄

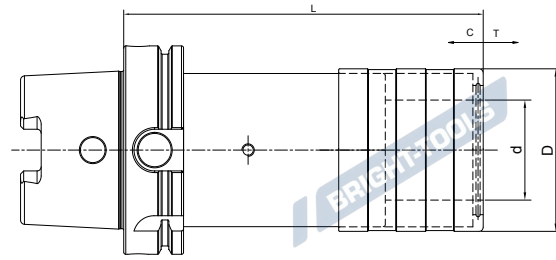

Size	d	D	L	T	C
HSK63A-TC312-102	19	36	102	7.5	7.5
HSK63A-TC820-140	31	53	140	12.5	12.5
HSK63A-TC1433-210	48	78	210	22	22
HSK100A-TC312-112	19	36	112	7.5	7.5
HSK100A-TC820-148	31	53	148	12.5	12.5
HSK100A-TC1433-210	48	78	210	22	22

HSK

Screw-in Milling Cutter Holder

锁牙刀柄, 锥柄型



A ↗ ≤0.005	RPM G2.5/25000	AD
---------------	-------------------	----

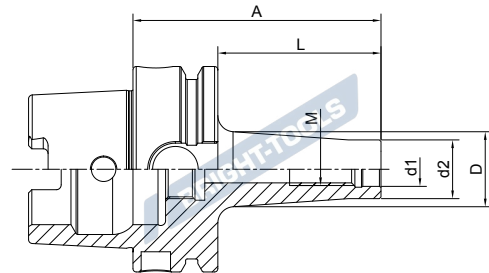

Size	M	d1	d2	A	L	D
HSK63A-SOM08-51 L=25	8	8.5	14.5	51	25	15
HSK63A-SOM08-76 L=50	8	8.5	14.5	76	50	23
HSK63A-SOM08-101 L=75	8	8.5	14.5	101	75	23
HSK63A-SOM10-51 L=25	10	10.5	18	51	25	20
HSK63A-SOM10-76 L=50	10	10.5	18	76	50	23
HSK63A-SOM10-126 L=100	10	10.5	18	126	100	32
HSK63A-SOM10-176 L=150	10	10.5	18	176	150	36.5
HSK63A-SOM12-51 L=25	12	12.5	21	51	25	24
HSK63A-SOM12-76 L=50	12	12.5	21	76	50	34
HSK63A-SOM12-101 L=75	12	12.5	21	101	75	31
HSK63A-SOM12-126 L=100	12	12.5	21	126	100	33
HSK63A-SOM12-176 L=150	12	12.5	21	176	150	40
HSK63A-SOM16-51 L=25	16	17	29	51	25	29
HSK63A-SOM16-76 L=50	16	17	29	76	50	34
HSK63A-SOM16-101 L=75	16	17	29	101	75	34
HSK63A-SOM16-126 L=100	16	17	29	126	100	36
HSK63A-SOM16-176 L=150	16	17	29	176	150	42.5
HSK100A-SOM08-79 L=50	8	8.5	14.5	79	50	23
HSK100A-SOM10-79 L=50	10	10.5	18	79	50	23
HSK100A-SOM10-129 L=100	10	10.5	18	129	100	32
HSK100A-SOM10-179 L=150	10	10.5	18	179	150	36.5
HSK100A-SOM12-79 L=50	12	12.5	21	79	50	24
HSK100A-SOM12-129 L=100	12	12.5	21	129	100	33
HSK100A-SOM12-179 L=150	12	12.5	21	179	150	40
HSK100A-SOM16-79 L=50	16	17	29	79	50	34
HSK100A-SOM16-129 L=100	16	17	29	129	100	36
HSK100A-SOM16-179 L=150	16	17	29	179	150	42.5

HSK



Screw-in Milling Cutter Holder

锁牙刀柄, 直柄型



A ↗ ≤0.005	RPM G2.5/25000	AD
---------------	-------------------	----

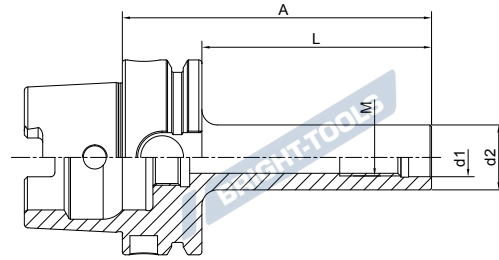

Size	M	d1	d2	A	L
HSK63A-M10-126 L=100	10	10.5	18	126	100
HSK63A-M10-176 L=150	10	10.5	18	176	150
HSK63A-M12-101 L=75	12	12.5	21	101	75
HSK63A-M12-126 L=100	12	12.5	21	126	100
HSK63A-M12-176 L=150	12	12.5	21	176	150
HSK63A-M16-101 L=75	16	17	29	101	75
HSK63A-M16-126 L=100	16	17	29	126	100
HSK63A-M16-176 L=150	16	17	29	176	150
HSK100A-M10-129 L=100	10	10.5	18	129	100
HSK100A-M10-179 L=150	10	10.5	18	179	150
HSK100A-M12-129 L=100	12	12.5	21	129	100
HSK100A-M12-179 L=150	12	12.5	21	179	150
HSK100A-M16-129 L=100	16	17	29	129	100
HSK100A-M16-179 L=150	16	17	29	179	150

HSK

Runout Adjustable Flange Adapter 可调节精度法兰刀柄

A ↗ ≤0.002	RPM G2.5/25000	AD
---------------	-------------------	----

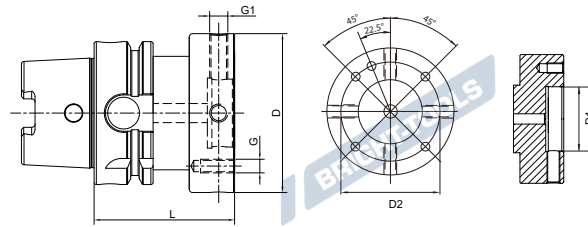

Size	HSK-A	D	D1	D2	L	G	G1
HSK50A-MOD060-060	50	60	30	44	60	M5	M8x1
HSK50A-MOD070-060	50	70	35	53	60	M6	M8x1
HSK50A-MOD080-060	50	80	40	63	60	M6	M8x1
HSK63A-MOD060-060	63	60	30	44	60	M5	M8x1
HSK63A-MOD070-060	63	70	35	53	60	M6	M8x1
HSK63A-MOD080-060	63	80	40	63	60	M6	M8x1
HSK63A-MOD100-065	63	100	50	79	65	M8	M10x1
HSK63A-MOD117-065	63	117	60	96	65	M8	M10x1
HSK80A-MOD060-050	80	60	30	44	50	M5	M8x1
HSK80A-MOD070-060	80	70	35	53	60	M6	M8x1
HSK80A-MOD080-060	80	80	40	63	60	M6	M8x1
HSK80A-MOD100-065	80	100	50	79	65	M8	M10x1
HSK80A-MOD117-065	80	117	60	96	65	M8	M10x1
HSK80A-MOD140-075	80	140	80	119	75	M10	M10x1
HSK100A-MOD060-055	100	60	30	44	55	M5	M8x1
HSK100A-MOD070-055	100	70	35	53	55	M6	M8x1
HSK100A-MOD080-055	100	80	40	63	55	M6	M8x1
HSK100A-MOD100-065	100	100	50	79	65	M8	M10x1
HSK100A-MOD117-065	100	117	60	96	65	M8	M10x1
HSK100A-MOD140-075	100	140	80	119	75	M10	M10x1
HSK125A-MOD060-55	125	60	30	44	55	M5	M8x1
HSK125A-MOD070-55	125	70	35	53	55	M6	M8x1
HSK125A-MOD080-55	125	80	40	63	55	M6	M8x1
HSK125A-MOD100-65	125	100	50	79	65	M8	M10x1
HSK125A-MOD117-65	125	117	60	96	65	M8	M10x1
HSK125A-MOD140-75	125	140	80	119	75	M10	M10x1
HSK160A-MOD060-55	125	60	30	44	55	M5	M8x1
HSK160A-MOD070-55	125	70	35	53	55	M6	M8x1
HSK160A-MOD080-55	125	80	40	63	55	M6	M8x1
HSK160A-MOD100-65	125	100	50	79	65	M8	M10x1
HSK160A-MOD117-65	125	117	60	96	65	M8	M10x1
HSK160A-MOD140-75	125	140	80	119	75	M10	M10x1

UM Adjustable Tool Holder

UM 调零刀柄

A ↗ ≤0.003	RPM G2.5/25000	AD
---------------	-------------------	----

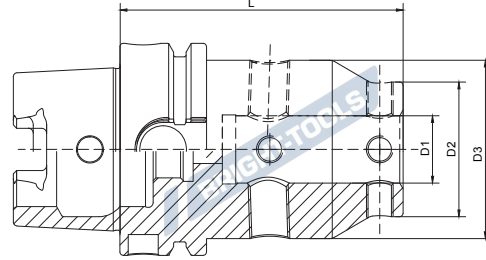

Size	D1	D2	D3	L
HSK50A-UM12-85	12	28	44.5	85
HSK50A-UM16-85	16	32	48	85
HSK50A-UM20-95	20	40	53	95
HSK50A-UM25-105	25	48	63	105
HSK50A-UM32-110	32	52	63	110
HSK63A-UM12-75	12	28	44.5	75
HSK63A-UM16-75	16	32	48	75
HSK63A-UM20-85	20	40	53	85
HSK63A-UM25-105	25	48	63	105
HSK63A-UM32-110	32	52	63	110
HSK100A-UM12-80	12	28	44.5	80
HSK100A-UM16-80	16	32	48	80
HSK100A-UM20-95	20	40	53	95
HSK100A-UM25-110	25	48	63	110
HSK100A-UM32-115	32	52	63	115

HSK

Boring Bar Blank

基础柄

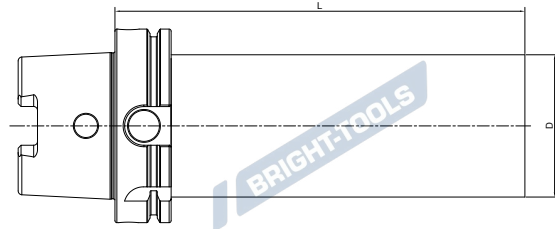

Size	D	L
HSK50A-D050-160	50	160
HSK50A-D065-200	65	200
HSK63A-D065-160	65	160
HSK63A-D065-210	65	210
HSK63A-D065-250	65	250
HSK63A-D065-300	65	300
HSK63A-D080-160	80	160
HSK63A-D080-210	80	210
HSK63A-D080-250	80	250
HSK63A-D080-300	80	300
HSK63A-D100-160	100	160
HSK63A-D100-210	100	210
HSK63A-D100-250	100	250
HSK63A-D100-300	100	300
HSK63A-D120-160	120	160
HSK63A-D120-210	120	210
HSK63A-D120-250	120	250
HSK63A-D120-300	120	300
HSK100A-D080-160	80	160
HSK100A-D080-210	80	210
HSK100A-D080-250	80	250
HSK100A-D080-300	80	300
HSK100A-D100-160	100	160
HSK100A-D100-210	100	210
HSK100A-D100-250	100	250
HSK100A-D100-300	100	300
HSK100A-D120-160	120	160
HSK100A-D120-210	120	210
HSK100A-D120-250	120	250
HSK100A-D120-300	120	300

HSK

HSK

Usage: used for special tools; taper and flange are hardened and grinded, soft blank side for later processing. Other sizes can be made by request.

Test Arbor
 主轴检测棒

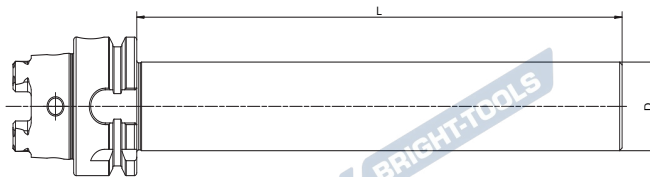
 A ↗
 ≤0.002

Size	D	L
HSK50A-32-200	32	200
HSK63A-40-300	40	300
HSK80A-50-300	50	300
HSK100A-50-300	50	300

HSK

Alignment Tool for ATC Arm 调整机械手用组合模具

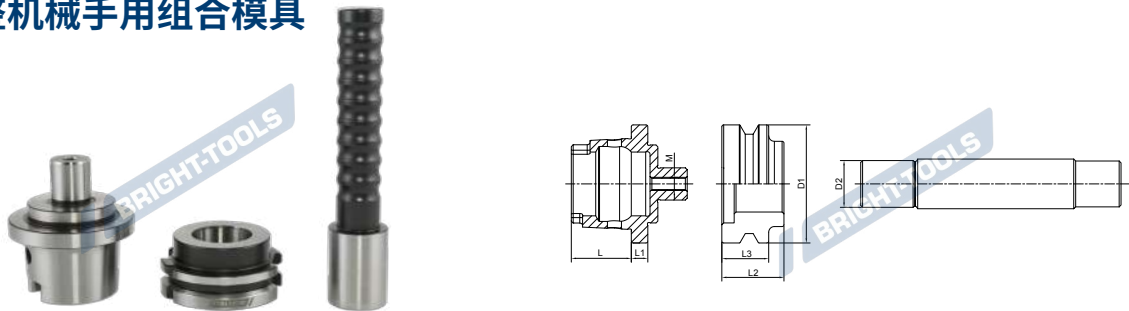

Size	D1	D2	L	L1	L2	L3	M
HSK50A-ATC-25D	50	25	25	8	22	18	M6
HSK63A-ATC-30D	63	30	32	8	30	18	M8
HSK80A-ATC-35D	80	35	40	8	36	18	M10
HSK100A-ATC-40D	100	40	50	10	45	19	M10

HSK

Alignment Tool for ATC Arm 调整机械手用组合模具

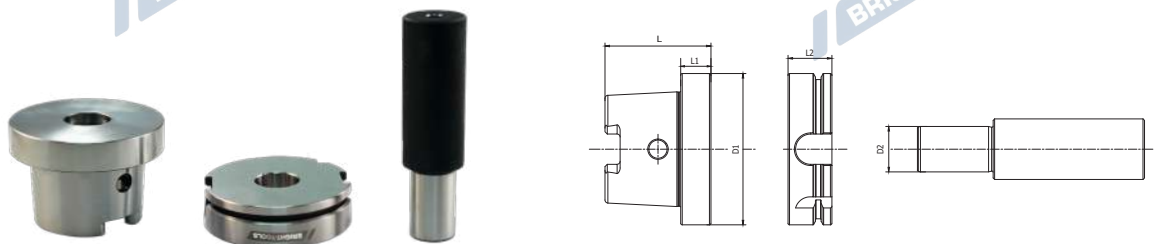

Size	D1	D2	L	L1	L2
HSK63A-ATC-20D	63	20	52	20	26
HSK100A-ATC-30D	100	30	70	20	29

Usage:

- 1) Put the Taper to the machine Spindle
- 2) Install flange to the ATC arm
- 3) Insert Pin into the flange
- 4) Adjust ATC arm and make sure the pin front part into the flange completely



BRIGHT-TOOLS

BRIGHT-TOOLS

TOOL HOLDERS

HSK-E

BRIGHT-TOOLS

BRIGHT-TOOLS

BRIGHT-TOOLS

BRIGHT-TOOLS

BRIGHT-TOOLS

BRIGHT-TOOLS

HSK-E Taper Standard

HSK-E 锥柄标准

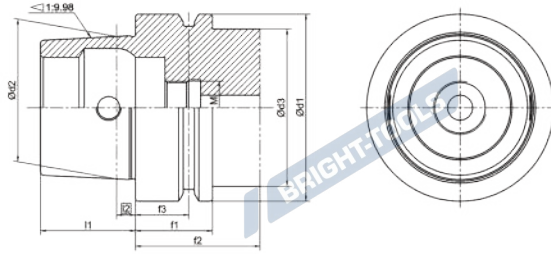
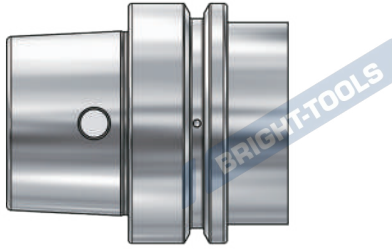

Size	d1	d2	d3	l1	l2	f1	f2	f3
HSK20E	20	15.203	16	10	2	8	16	3.5
HSK25E	25	19.006	20	13	2.5	10	20	4.5
HSK32E	32	24.007	26	16	3.2	20	35	16
HSK40E	40	30.007	34	20	4	20	35	16
HSK50E	50	38.009	42	25	5	26	42	18
HSK63E	63	48.010	53	32	6.3	26	42	18

Taper standard: DIN 69893; ISO 12164

Material: Alloyed case hardened steel

Surface Treatment: Blackening and Bright

Taper tolerance: <AT3

Hardness: HRC 56-60

Carbon depth: 0.8±0.2mm

Surface Roughness: Ra<0.2µm

Balancing: G6.3/15000; G2.5/25000

HSK-E TOOLING SYSTEM HSK-E 工具系统目录

ER Collet Chuck.....	G.39
ER 弹簧夹头刀柄	
Face Mill Holder.....	G.41
面铣刀柄	
End Mill Holder.....	G.42
侧固刀柄	
Test Arbor.....	G.43
主轴检测棒	



HSK

ER Collet Chuck

ER 弹簧夹头刀柄

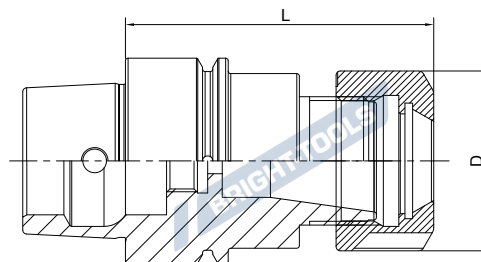
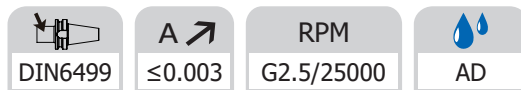

Size	D	L	Capacity
HSK32E-ER11M-60	16	60	1-7
HSK32E-ER16M-60	22	60	1-10
HSK32E-ER20M-60	28	60	1-13
HSK32E-ER16A-60	28	60	1-10
HSK32E-ER20A-60	34	60	1-13
HSK40E-ER16A-60	28	60	1-10
HSK40E-ER20A-60	34	60	1-13
HSK40E-ER25-60	42	60	2-16
HSK40E-ER32-70	50	70	2-20
HSK50E-ER16A-80	28	80	1-10
HSK50E-ER25-80	42	80	2-16
HSK50E-ER32-85	50	85	2-20
HSK50E-ER40-100	63	100	3-26
HSK63E-ER16A-75	28	75	1-10
HSK63E-ER25-80	42	80	2-16
HSK63E-ER32-90	50	90	2-20
HSK63E-ER40-120	63	120	3-26

HSK

Face Mill Holder
面铣刀柄

DIN6499	A ≤ 0.005	RPM G2.5/25000	AD
---------	----------------	----------------	----

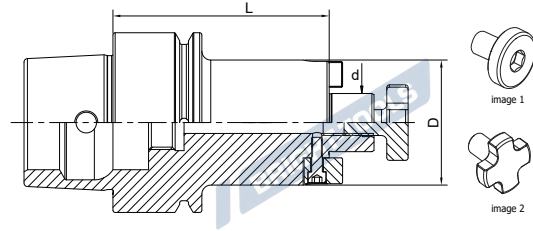

Size	d	D	L1
HSK32E-FMB16-50	16	38	50
HSK40E-FMB16-50	16	38	50
HSK40E-FMB22-50	22	48	50
HSK40E-FMB27-55	27	58	55
HSK50E-FMB16-50	16	38	50
HSK50E-FMB22-60	22	48	60
HSK50E-FMB27-60	27	58	60
HSK50E-FMB32-60	32	78	60
HSK63E-FMB16-50	16	38	50
HSK63E-FMB22-60	22	48	60
HSK63E-FMB27-60	27	58	60
HSK63E-FMB32-60	32	78	60

Face mill holder is with retaining screw (image 2) except China, it is with universal screw (image 1) in China.
中国市场面铣刀柄标配圆头螺钉 (图 1), 其他国家标配十字花螺钉 (图 2).

Face Mill Holder
面铣刀柄

DIN6499	A ≤ 0.005	RPM G2.5/25000	AD
---------	----------------	----------------	----

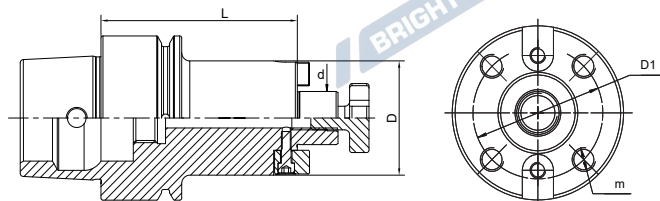

Size	d	D	D2	L	M	m
HSK63E-FMB40-60	40	88	66.7	60	M20	M12

FMB40 tool holder is with one retaining screw (image 2) . but it is with one universal screw (image 1) in China.

FMB40 刀柄中国市场面铣刀柄标配圆头螺钉 (图 1), 其他国家标配十字花螺钉 (图 2).

End Mill Holder Weldon 侧固刀柄

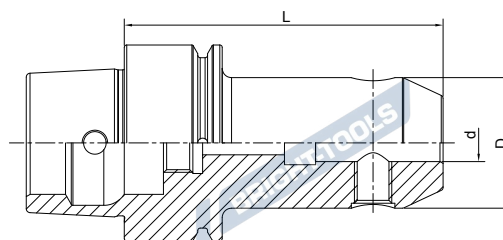

Size	d	D	L	M	Screw Quantity
HSK32E-SLA06-60	6	25	60	M6	1
HSK32E-SLA08-60	8	28	60	M8	1
HSK32E-SLA10-65	10	35	65	M10	1
HSK40E-SLA06-60	6	25	60	M6	1
HSK40E-SLA08-60	8	28	60	M8	1
HSK40E-SLA10-60	10	35	60	M10	1
HSK40E-SLA12-70	12	42	70	M12	1
HSK40E-SLA14-75	14	44	75	M12	1
HSK40E-SLA16-75	16	48	75	M14	1
HSK40E-SLA20-75	20	52	75	M16	1
HSK50E-SLA06-65	6	25	65	M6	1
HSK50E-SLA08-65	8	28	65	M8	1
HSK50E-SLA10-65	10	35	65	M10	1
HSK50E-SLA12-80	12	42	80	M12	1
HSK50E-SLA14-80	14	44	80	M12	1
HSK50E-SLA16-80	16	48	80	M14	1
HSK50E-SLA18-80	18	50	80	M14	1
HSK50E-SLA20-80	20	52	80	M16	1
HSK50E-SLA20-100	20	52	100	M16	1
HSK50E-SLA25-102	25	65	102	M18*2	2
HSK63E-SLA06-65	6	25	65	M6	1
HSK63E-SLA08-65	8	28	65	M8	1
HSK63E-SLA10-65	10	35	65	M10	1
HSK63E-SLA12-80	12	42	80	M12	1
HSK63E-SLA14-80	14	44	80	M12	1
HSK63E-SLA16-80	16	48	80	M14	1
HSK63E-SLA18-80	18	50	80	M14	1
HSK63E-SLA20-80	20	52	80	M16	1
HSK63E-SLA25-110	25	65	110	M18*2	2
HSK63E-SLA32-110	32	72	110	M20*2	2
HSK63E-SLA40-120	40	80	120	M20*2	2

Test Arbor
主轴检测棒

A ↗
≤0.002

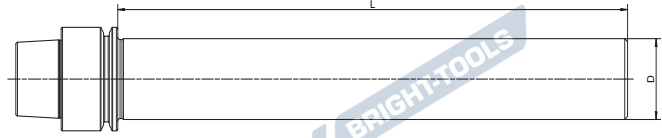

Size	D	L
HSK25E-20-150	20	150
HSK32E-25-180	25	180
HSK40E-25-180	25	180
HSK50E-32-200	32	200

HSK

BRIGHT-TOOLS

BRIGHT-TOOLS

BRIGHT-TOOLS

BRIGHT-TOOLS

BRIGHT-TOOLS

BRIGHT-TOOLS

BRIGHT-TOOLS

BRIGHT-TOOLS

TOOL HOLDERS

HSK-F

BRIGHT-TOOLS

BRIGHT-TOOLS

BRIGHT-TOOLS

BRIGHT-TOOLS

BRIGHT-TOOLS

BRIGHT-TOOLS

HSK-F Taper Standard

HSK-F 锥柄标准

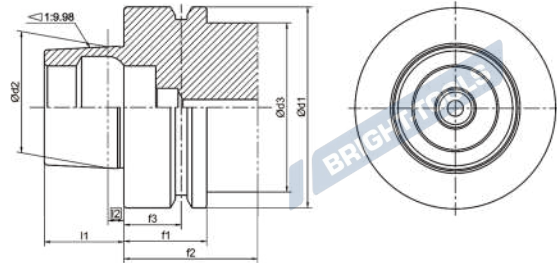
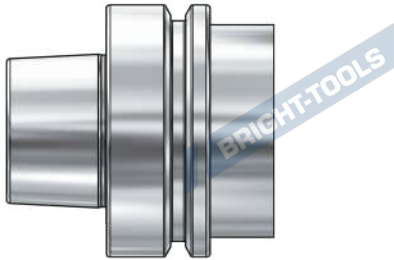

Size	d1	d2	d3	l1	l2	f1	f2	f3
HSK50F	50	30.007	42	20	4	26	42	18
HSK63F	63	38.009	53	25	5	26	42	18
HSK80F	80	48.010	68	32	6.3	26	42	18

Taper standard: DIN 69893; ISO 12164
Material: Alloyed case hardened steel
Surface Treatment: Blackening and Bright
Taper tolerance: <AT3
Hardness: HRC 56-60
Carbon depth: 0.8±0.2mm
Surface Roughness: Ra<0.2µm
Balancing: G6.3/15000; G2.5/25000

HSK-F TOOLING SYSTEM HSK-F 工具系统目录

ER Collet Chuck.....G.48	
ER 弹簧夹头刀柄	
OZ Collet Chuck.....G.48	
OZ 夹头刀柄	
Face Mill Holder.....G.49	
面铣刀柄	
End Mill Holder.....G.49	
侧固刀柄	
Morse Taper AdapterG.50	
带扁尾莫氏刀柄	
Boring Bar Blank.....G.50	
基础柄	
Precision Drill Chuck HolderG.51	
精密钻夹头刀柄	
Test ArborG.51	
主轴检测棒	



HSK

ER Collet Chuck

ER 弹簧夹头刀柄

DIN6499	A ≤ 0.003	RPM G2.5/25000	AD
---------	----------------	----------------	----

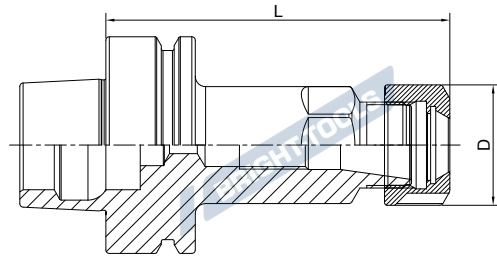

Size	D	L	Capacity
HSK40F-ER16-60	28	60	1-10
HSK40F-ER25-60	42	60	2-16
HSK50F-ER25-70	42	70	2-16
HSK50F-ER32-80	50	80	2-20
HSK50F-ER40-80	63	80	3-26
HSK63F-ER16-60	28	60	1-10
HSK63F-ER25-70	42	70	2-16
HSK63F-ER32-75	50	75	2-20
HSK63F-ER40-80	63	80	3-26
HSK63F-ER16-100	28	100	1-10
HSK63F-ER25-100	42	100	2-16
HSK63F-ER32-100	50	100	2-20
HSK63F-ER40-100	63	100	3-26

HSK

OZ Collet Chuck

OZ 夹头刀柄

DIN6391	A ≤ 0.005	RPM G2.5/25000	AD
---------	----------------	----------------	----

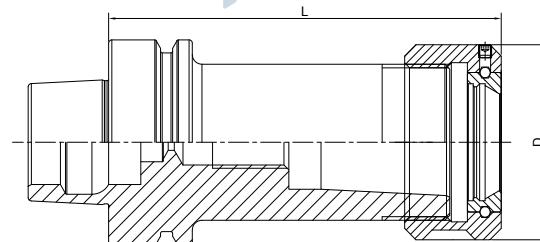

Size	D	L	Capacity
HSK63F-OZ25-90	60	90	3-25

Face Mill Holder 面铣刀柄



DIN6357	A ≤ 0.005	RPM G2.5/25000	AD
---------	----------------	----------------	----

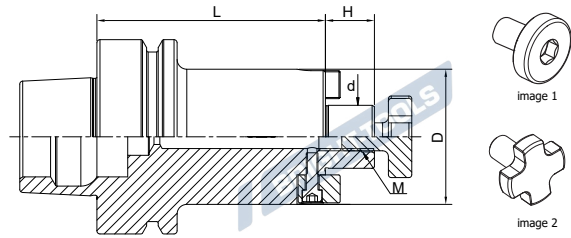

Size	d	D	L	H	M
HSK63F-FMB16-50	16	38	50	17	M8
HSK63F-FMB22-60	22	48	60	19	M10
HSK63F-FMB27-60	27	58	60	21	M12
HSK63F-FMB32-60	32	78	60	24	M16

Face mill holder is with retaining screw (image 2) except China, it is with universal screw (image 1) in China. 中国市场面铣刀柄标配圆头螺钉 (图 1), 其他国家标配十字花螺钉 (图 2).

HSK

End Mill Holder Weldon 侧固刀柄



DIN6359/1835B	A ≤ 0.005	RPM G2.5/25000	AD
---------------	----------------	----------------	----

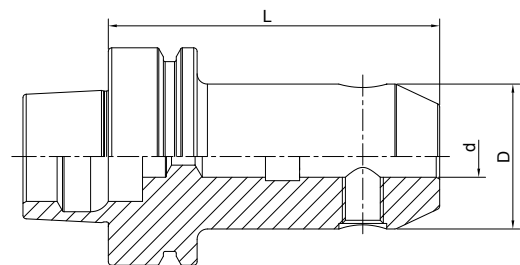

Size	d	D	L	M	Screw Quantity
HSK63F-SLA06-65	6	25	65	M6	1
HSK63F-SLA08-65	8	28	65	M8	1
HSK63F-SLA10-65	10	35	65	M10	1
HSK63F-SLA12-80	12	42	80	M12	1
HSK63F-SLA14-80	14	44	80	M12	1
HSK63F-SLA16-80	16	48	80	M14	1
HSK63F-SLA18-80	18	50	80	M14	1
HSK63F-SLA20-80	20	52	80	M16	1
HSK63F-SLA25-110	25	65	110	M18*2	2
HSK63F-SLA32-110	32	72	110	M20*2	2

Morse Taper Adapter with Tang

带扁尾莫氏刀柄

DIN6383

A ≤ 0.005

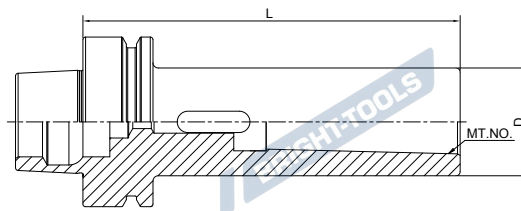
RPM
G2.5/25000

Size	MT.NO.	D	L
HSK63F-MTA1-100	1	25	100
HSK63F-MTA2-120	2	32	120
HSK63F-MTA3-140	3	40	140
HSK63F-MTA4-160	4	48	160

HSK

Boring Bar Blank

基础柄

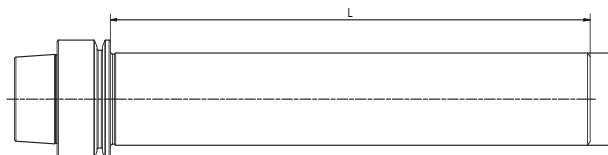

Size	D	L
HSK63F-65-160	65	160
HSK63F-65-250	65	250

Other sizes can be made by request.

Precision Drill Chuck Holder
精密钻夹头刀柄

A ↗	RPM
≤0.03	G2.5/25000

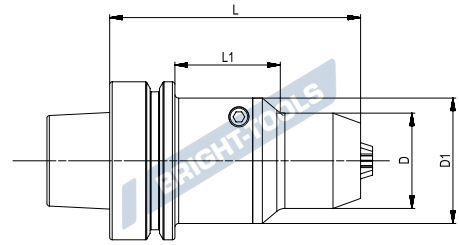

Size	D	D1	L	L1	Capacity
HSK63F-CPU10-90	38	50	90	32	1-10
HSK63F-CPU13-100	50	-	100	-	1-13
HSK63F-CPU16-100	50	-	100	-	1-16

HSK

Test Arbor
主轴检测棒

A ↗
≤0.002

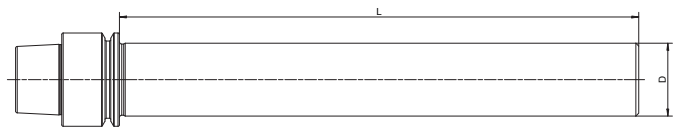

Size	D	L
HSK63F-40-300	40	300